

PFC Micro™

Power Factor Corrected AC-DC Switcher



Design Guide

and

“Quick Install” Instructions



www.vicorpower.com

TABLE OF CONTENT

| | |
|---------------------------------|----|
| Overview of Product..... | 3 |
| Part Numbering..... | 3 |
| Mechanical Considerations..... | 4 |
| PFC Micro Do's and Don'ts..... | 4 |
| Technical Description..... | 5 |
| Quick Install Instructions..... | 6 |
| Mechanical Drawings..... | 8 |
| Output Connections..... | 9 |
| Interface Connections..... | 10 |
| Specifications..... | 15 |
| Output Power Derating..... | 17 |
| Current Share Board..... | 19 |

PFC Micro™

Power Factor Corrected AC-DC Switcher

Overview

The PFC Micro is an ultra low profile switching power supply that combines the advantages of power factor correction (PFC) and high power density. It provides up to 6 isolated outputs (from 2 slots) and each slot accommodates the following Vicor DC - DC Converters:

VI-200/VI-J00: 2 VI-200 or 4 VI-J00

Maxi/Mini/Micro Series: 2 Maxis, 4 Minis or 6 Micros.

The use of these converters gives the PFC Micro the inherent power flexibility typical of all Vicor products. Accepting input voltages of 85 Vac to 264 Vac, and 100 to 300 Vdc, the PFC Micro can provide up to 800 Watts in a package size of 1.86" H (47.3mm) x 5.06" W (128,5mm) x 10.40" L (264,1mm). The PFC Micro is factory configured to meet user output requirements.

Standard Features

- Power Factor Correction: Typically 0.98 (>75% Load)
- Universal Input: 85-264 Vac, 47-500 Hz, or 100-300 Vdc
- Power Output: 800W at 230 Vac (200 Vac minimum input) ; 500W at 115 Vac (100 Vac minimum input)
- Up to 6 isolated outputs (2 slots)
- Fan cooled
- Full power to 45°C; half power at 65°C
- Soft start for limiting inrush current
- Conducted EMI: FCC Class A
EN 55022 Class A (consult factory)
- Harmonic Distortion to EN61000-3-2
- AC Power OK status signal
- RoHS compliant available
- Output Sequencing and General Shutdown
- Autosense (Refer to page 6 and 11 for more information on Autosense)
- Output overcurrent protection on all outputs
- Output overvoltage protection (not applicable when using VI-J00)
- Output overtemperature limiting (not applicable when using VI-J00)
- Ride-through (holdup) time: >20 ms at 500W load
- **Size: 1.86" H (47,3mm) x 5.06" W (128,5mm) x 10.4" L (264,1mm)**
- Safety Agency Approvals: CE Marking, TUV CUE
- Uses 300 Vdc input VI-200/VI-J00 modules and/or 375 Vdc input Maxi/Mini/Micro modules
- Power good status signal (on Maxi Products)

Optional Features

- I-grade screened output converters
- Current Share Board for unit to unit power sharing- See page 19 and page 20
- Connector kits (# 19-130044)

Part Numbering

| | | | |
|------------------|---|----------------------|--|
| PFC Micro | PCx₁-x₂ x₃ (x₄)-xxxx-x₅ | x₁ | Number of outputs |
| | e.g. PC6-06-5012-G | x₂ | Number of VI-200/VI-J00 modules |
| | | x₃ | Number of Maxi, Mini and Micro modules |
| | | x₄ | Optional Factory assigned |
| | | xxxx | Sequential number assigned by Westcor |
| | | x₅ | Optional Factory assigned |

Mechanical Considerations

The PFC Micro can be mounted on one of three surfaces using standard 8-32 or 4 mm screws. Maximum allowable torque is 5 in. lbs., and the maximum penetration of 0.25 in (6mm) on the sides and 0.125 in. (3mm) on the bottom.

When selecting a mounting location and orientation, the unit should be positioned so air flow is not restricted. Maintain a 2" (5,1cm) minimum clearance at both ends of the PFC Micro, and route all cables so airflow is not obstructed. The power supply draws air in at the fan side/AC input side and exhausts air out the load side. If airflow ducting is used, avoid sharp turns that could create back pressure. The fan moves approximately 10 CFM of air.

Avoid excessive bending of output power cables after they are connected to the output terminals. For high-current outputs, use cable ties to support heavy cables and minimize mechanical stress on connectors. Be careful not to short-out to neighboring outputs. The maximum torque recommended on output nuts is 10 in. lbs.

Avoid applications in which the unit is exposed to excessive shock or vibration levels as the unit is designed primarily for office type equipment. In such applications, a shock absorbing mount design is required.

PFC Micro Do's and Don'ts

- Do not restrict airflow to the unit. The cooling fan draws air into the unit and forces it out at the output power terminals. A minimum of 2" in front and behind the supply should be maintained in order to prevent air obstructions.
- Run the output (+/-) power cables next to each other to minimize inductance.
- Do not attempt to repair or modify the power supply in any manner. In the event of problems, contact Customer Service at 1-800-735-6200..
- Insert proper fault protection at power supply input terminals (i.e., a fuse).
- Use proper size wires to avoid overheating and excessive voltage drop.

Technical Description

The PFC Micro consists of an off-line single phase, power-factor-corrected front end, EMI filter, cooling fan, customer interface, power supply control circuit, associated housekeeping circuits, and a selection of Vicor's VI-200/VI-J00 and/or Maxi DC-DC converters.

Input AC mains voltage is applied to input connector MB1J1. The input current is passed through an EMI filter designed to meet conducted noise limit "A" specifications of FCC Part 15.

At start-up, inrush current is limited by a PTC thermistor. The PTC is shunted out shortly after initial power-up by a DC bus voltage sense circuit driving a relay. After rectification, the input voltage is put through a boost converter that keeps the AC input current sinusoidal and synchronized with the input AC voltage (in compliance with EN61000). The boost converter delivers a regulated input to the hold-up capacitors and a high voltage backplane. The backplane supplies power to the DC-DC converters that provide the desired low voltage regulated outputs.

Output voltage conversion is achieved by Vicor's family of Zero-Current-Switching (ZCS) DC-DC converters. These are forward converters in which the main switching element switches at zero current. This patented topology has a number of unique attributes: low switching losses; high frequency operation, resulting in reduced size for magnetics and capacitors; excellent line and load regulation; wide adjustment range for output; low EMI/RFI emission and high efficiencies.

At initial power-up, the PFC Micro outputs are disabled to limit the inrush current and to allow the DC bus potential to settle out to the correct operating level. A low-power flyback converter converts the high voltage DC bus into regulated low voltage to power the internal housekeeping circuits and DC cooling fan.

The internal housekeeping Vcc comes up within 1 s after the application of input power. Once the high voltage bus is within operating limits, the AC Power OK signal asserts to a TTL "1," indicating the input power is OK, and the power outputs will come up 250 ms later.

An output Enable/Disable function is provided to control Vicor's DC-DC converters. If the Enable/Disable control pin is pulled low, the modules output is disabled. The nominal delay associated for an output to come up when measured from release of the Enable/Disable pin is 9-12 ms. The General Shutdown function controls all outputs simultaneously and works in a similar manner.

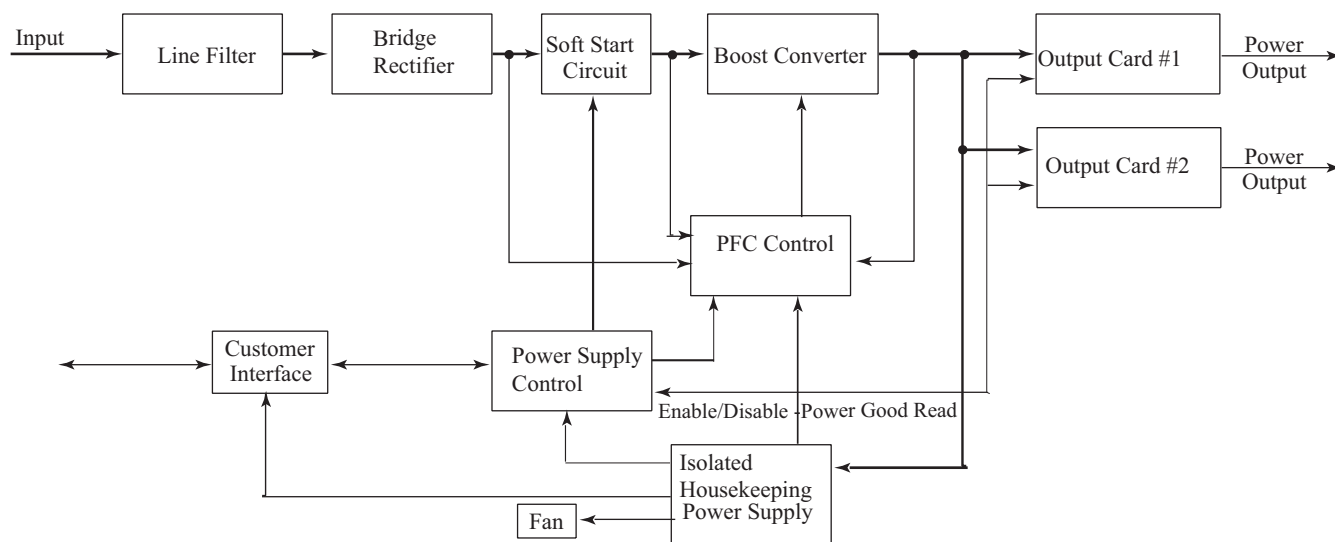

Figure 1. PFC Micro Architecture

PFC Micro “Quick Install” Instructions (For mechanical drawings, see page 8)

Mounting the PFC Micro

- * The PFC Micro can be mounted on either of three sides.
- * Use #8-32 or 4mm mounting screws. Maximum penetration should not exceed 0.25in. (6mm) on the side and 0.125 in. (3mm) on the bottom.
- * Maintain 2" (5,1cm) clearance at both ends of power supply for airflow.

Input Connections

Input Power MBJ1

- * Input AC power is applied to connector MBJ1.
- * Maximum torque is 5 in.lbs
- * **A fuse or circuit breaker in the input line is necessary for safety requirements (7.5A).**
- * Molex mating receptacle 39-01-4051, terminals 39-00-0090, crimp tool Molex # 11-01-0199.

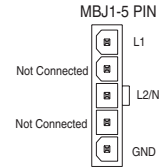

Output Connections

Power Connections

Installing **bus bars** on output studs (when full size module used):

- * The right stud is Positive and the left stud is the Return on single output cards.
- * Remove the nut and place ring lug over output stud.
- * Replace and tighten the nut to a torque of **10 inch pounds**.
- Do Not Over-Tighten Nuts.**

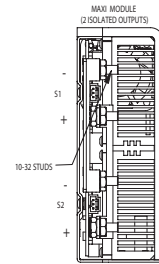

Installing power connectors **with 18 pin Molex connectors** (when half size modules used):

- * S1/S2 J1-7, S1/S2 J1-8 and S1/S2 J1-16 are Positive for output #1, while pins S1/S2 J1-9, S1/S2 J1-17 and S1/S2 J1-18 are the Returns. S1/S2 J1-1, S1/S2 J1-10 and S1/S2 J1-11 are Positive for output #2, while pins S1/S2 J1-2, S1/S2 J1-3 and S1/S2 J1- 12 are the Returns.
- * For this 18 pin housing, use Molex mating receptacle #39-01-2180 with #39-00-0039 terminals.
- * Attach 24-30 AWG stranded wire using Molex tool #11-01-0197.

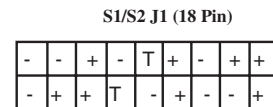
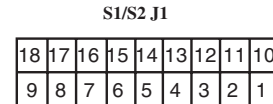

Installing power connectors **with 16 pin Molex connectors** (when quarter size modules used):

- * S1/S2 J1-7 and S1/S2 J1- 15 are Positive for output #1, while pins S1/S2 J1-8 and S1/S2 J1- 16 are the Return. S1/S2 J1-4 and S1/S2 J1-12 are Positive for output #2, while pins S1/S2 J1-5 and S1/S2 J1- 13 are the Return. S1/S2 J1-1 and S1/S2 J1-9 are Positive for output # 3, while pins S1/S2 J1-2, and S1/S2 J1-10 are the Returns.
- * For this 16 pin housing, use Molex mating receptacle #39-01-2160 with #39-00-0039 terminals.
- * Attach 24-30 AWG stranded wire using Molex tool #11-01-0197.

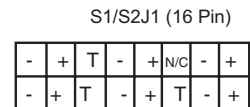
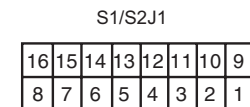

Sense Connections

Sense Connections on output connections with studs:

- * The PFC Micro is shipped with Autosense installed (For more information on Autosense, refer to page 12)
- * For Remote Sense, connect Remote Sense wires to Remote Sense/Trim Pin Access Connector S1/S2 J2.
- * Connector pin S1/S2 J2-2 is the +Sense and S1/S2 J2-3 is the -Sense.
- * Use Molex mating receptacle #50-57-9403 with #16-02-0103 terminals.
- * Attach terminals to 24-30 AWG stranded twisted pair wire using Molex tool # 11-01-0208.
- * Attach opposite end of sense lines to their respective outputs to point where regulation is desired. **Verify that sense lines are not cross-connected.**

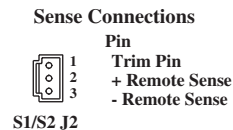

Sense Connections on output connections with 18 pin Molex connectors:

- * The PFC Micro is shipped with Autosense installed (For more information on Autosense, refer to page 11)
- * If Remote Sense is desired, connect Remote Sense wires to sense lines of Connector S1/S2 J1.
- * Connector pin S1/S2 J1- 13 is the +Sense and S1/S2 J1- 15 is the -Sense for output #1. S1/S2 J1- 4 is the +Sense and S1/S2 J1- 5 is the -Sense for output #2.
- * Use Molex mating receptacle #39-01-2180 with #39-00-0039 terminals.
- * Attach 24-30 AWG stranded twisted pair wire using Molex tool #11-01-0197

Note: Remote Sense is NOT available for triple output slots.

S1/S2 J1

| | | | | | | | | |
|----|----|----|----|----|----|----|----|----|
| 18 | 17 | 16 | 15 | 14 | 13 | 12 | 11 | 10 |
| 9 | 8 | 7 | 6 | 5 | 4 | 3 | 2 | 1 |

S1/S2 J1 (18 Pin)

| | | | | | | | | |
|---|---|---|---|---|---|---|---|---|
| - | - | + | - | T | + | - | + | + |
| - | + | + | T | - | + | - | - | + |

Trim Connections

Trim Connections on output with studs :

- * S1/S2 J2-1 provides Trim access.
- * Use Molex mating receptacle #50-57-9403 with #16-02-0103 terminals.
- * Attach 24-30 AWG stranded wire using Molex tool #11-01-0208.

Trim Connections on connector with 18 pin molex connectors:

- * S1/S2 J1-6 provides Trim access for output #1, and S1/S2 J1-14 provides Trim access for output #2.
- * Use Molex mating receptacle #39-01-2180 with #39-00-0039 terminals.
- * Attach 24-30 AWG stranded wire using Molex tool #11-01-0197.

Trim Connections on connectors with 16 pin Molex connectors:

- * S1/S2 J1-14 provides Trim access for output #1, and S1/S2 J1-6 provides Trim access for output #2, and S1/S2 J1-3 provides Trim access for output #3.
- * Use Molex mating receptacle #39-01-2180 with #39-00-0039 terminals.
- * Attach 24-30 AWG stranded wire using Molex tool #11-01-0197.

Trim Connections

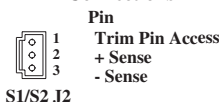

S1/S2 J1

| | | | | | | | | |
|----|----|----|----|----|----|----|----|----|
| 18 | 17 | 16 | 15 | 14 | 13 | 12 | 11 | 10 |
| 9 | 8 | 7 | 6 | 5 | 4 | 3 | 2 | 1 |

S1/S2 J1 (18 Pin)

| | | | | | | | | |
|---|---|---|---|---|---|---|---|---|
| - | - | + | - | T | + | - | + | + |
| - | + | + | T | - | + | - | - | + |

S1/S2J1

| | | | | | | | |
|----|----|----|----|----|----|----|---|
| 16 | 15 | 14 | 13 | 12 | 11 | 10 | 9 |
| 8 | 7 | 6 | 5 | 4 | 3 | 2 | 1 |

S1/S2J1 (16 Pin)

| | | | | | | | |
|---|---|---|---|---|-----|---|---|
| - | + | T | - | + | N/C | - | + |
| - | + | T | - | + | T | - | + |

Interface Connections

- * CBJ3-1 is Signal Ground, CBJ3-2 is Power Good Read and CBJ3-3 is AC-OK.
- * CBJ3-4-9 are Enable/Disable, CBJ3-10 is General Shutdown, CBJ3-11 is Power Good Data Valid (PGDV) and CBJ3-12 is +5VS.
- * Use Molex mating receptacle #50-57-9412 with #16-02-0097 cinch pins.
- * Attach terminals to 24-30 AWG stranded wire.

CBJ3 E/D INTERFACE CONNECTOR

MATING CONNECTOR: (WESTCOR KIT P/N: 19-130044)
HOUSING: MOLEX (50-57-9412)
SOCKET CRIMP 24-30 AWG: MOLEX (16-02-0097)
CRIMP TOOL: MOLEX (11-01-0209)

| PIN | DESCRIPTION |
|-----|--------------|
| 1 | CBJ3-1 SGND |
| 2 | CBJ3-2 PGR |
| 3 | CBJ3-3 ACOK |
| 4 | CBJ3-4 ED6 |
| 5 | CBJ3-5 ED5 |
| 6 | CBJ3-6 ED4 |
| 7 | CBJ3-7 ED3 |
| 8 | CBJ3-8 ED2 |
| 9 | CBJ3-9 ED1 |
| 10 | CBJ3-10 GSD |
| 11 | CBJ3-11 PGDV |
| 12 | CBJ3-12 +5VS |

Output Connections for the PFC Micro

A. OUTPUT STUDS - SINGLE OUTPUT (when populated with full size module)

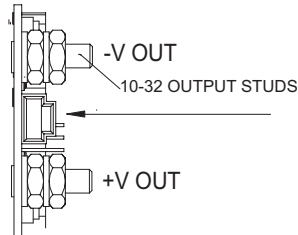

SxJ2 REMOTE SENSE/TRIM
PIN CONNECTOR

| | |
|---|---------|
| 3 | - SENSE |
| 2 | + SENSE |
| 1 | TRIM |

MATING CONNECTOR:
HOUSING: MOLEX (50-57-9403)
TERMINAL FEM CRIMP 24-30 AWG: MOLEX (16-02-0103)
USE CRIMP TOOL: MOLEX (11-01-0208)

B. 18 PIN MOLEX CONNECTOR - SINGLE OR DUAL OUTPUTS (when populated with half size modules)

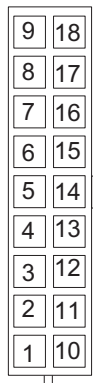

SxJ1 (18 PIN OUTPUT, REMOTE SENSE
AND TRIM PIN CONNECTOR)

| PIN | DESCRIPTION | PIN | DESCRIPTION |
|-----|-------------|-----|-------------|
| 1 | +V OUT M2 | 10 | +V OUT M2 |
| 2 | -V OUT M2 | 11 | +V OUT M2 |
| 3 | -V OUT M2 | 12 | -V OUT M2 |
| 4 | + SENSE M2 | 13 | + SENSE M1 |
| 5 | - SENSE M2 | 14 | TRIM M2 |
| 6 | TRIM M1 | 15 | - SENSE M1 |
| 7 | +V OUT M1 | 16 | +V OUT M1 |
| 8 | +V OUT M1 | 17 | - V OUT M1 |
| 9 | -V OUT M1 | 18 | - V OUT M1 |

MATING CONNECTOR:
18 PIN HOUSING: MOLEX (39-01-2180)
TERMINAL FEM CRIMP 18-24 AWG: MOLEX (39-00-0039)
USE CRIMP TOOL: MOLEX (11-01-0197)

C. 16 PIN MOLEX CONNECTOR - SINGLE, DUAL, TRIPLE OUTPUTS (when populated with quarter size modules)



*SxJ1 (16 PIN OUTPUT, REMOTE SENSE
AND TRIM PIN CONNECTOR)

| PIN | DESCRIPTION | PIN | DESCRIPTION |
|-----|-------------|-----|-------------|
| 1 | +V OUT M3 | 9 | +V OUT M3 |
| 2 | -V OUT M3 | 10 | -V OUT M3 |
| 3 | TRIM M3 | 11 | N/C |
| 4 | +V OUT M2 | 12 | +V OUT M2 |
| 5 | -V OUT M2 | 13 | -V OUT M2 |
| 6 | TRIM M2 | 14 | TRIM M1 |
| 7 | +V OUT M1 | 15 | +V OUT M1 |
| 8 | -V OUT M1 | 16 | -V OUT M1 |

MATING CONNECTOR:
16 PIN HOUSING: MOLEX (39-01-2160)
TERMINAL FEM CRIMP 18-24 AWG: MOLEX (39-00-0039)
USE CRIMP TOOL: MOLEX (11-01-0197)

OPTIONAL CONNECTOR KIT FOR PFC MICRO (PART# 19-130044. Available for purchase from Westcor)

| ITEM | QTY | DESCRIPTION | VENDOR # 1 | PART NO. |
|---|-----|-----------------------------------|------------|------------|
| 1 | 3 | HOUSING 3 POS .100 CTR W/LATCH | MOLEX | 50-57-9403 |
| 2 | 8 | TERM FEM CRIMP 22-24AWG SEL GOLD | MOLEX | 16-02-0103 |
| ** | | CRIMP TOOL FOR ITEM 2 | MOLEX | 11-01-0208 |
| 3 | 2 | HOUSING 16 POS .165 CTRS W/LATCH | MOLEX | 39-01-2160 |
| 4 | 2 | HOUSING 18 POS .165 CTRS W/LATCH | MOLEX | 39-01-2180 |
| 5 | 40 | TERM FEM CRIMP 18-24 AWG SEL GOLD | MOLEX | 39-00-0039 |
| ** | | CRIMP TOOL FOR ITEM 5 | MOLEX | 11-01-0197 |
| 6 | 40 | TERMINAL CRIMP 16 AWG SEL GOLD | MOLEX | 45750-3211 |
| ** | | CRIMP TOOL FOR ITEM 6 | MOLEX | 11-01-0199 |
| 7 | 1 | HOUSING 5 POS .165 CTRS W/LATCH | MOLEX | 39-01-4051 |
| 8 | 5 | TERM FEM CRIMP 16 AWG SEL GOLD | MOLEX | 45750-3211 |
| | | CRIMP TOOL FOR ITEM 8 | MOLEX | 11-01-0199 |
| 9 | 1 | HOUSING 12 POS .10 CTRS W/LATCH | MOLEX | 50-57-9412 |
| 10 | 14 | TERMINAL CRIMP 24-30 AWG SEL GOLD | MOLEX | 16-02-0097 |
| ** | | CRIMP TOOL FOR ITEM 10 | MOLEX | 11-01-0209 |
| ** ITEMS FOR REF ONLY (NOT INCLUDED IN KIT) | | | | |

Interface Connections

Chassis Input Power Terminals (MBJ1)

Input AC power is applied through connector MBJ1 using Molex mating connector 39-01-4051. Use 16 AWG wire with Molex Socket Pin 39-00-0090 and Crimp Tool 11-01-0199.

A fault clearing device, such as a fuse or circuit breaker, with a maximum 7.5A rating at the power supply input is required for safety agency compliance. It should be sized to handle the start-up inrush current of 5A rms at 115 Vac and 10A rms at 230 Vac.

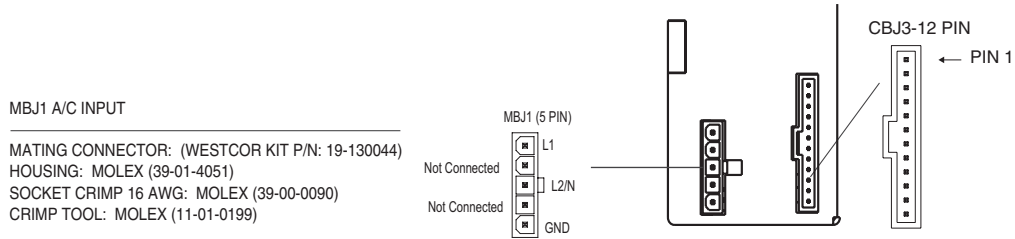

Figure 2. Input Power Terminal MBJ1

Output Power Connections

There are three types of output power terminals available in the PFC Micro. Each slot has one of the following configurations: 10-32 plated steel bolts from outputs using full size converters, an 18 pin Molex connector for outputs using half size converters and a 16 pin Molex connector for outputs using quarter size converters. The positive polarity of the single output termination is the right bolt when viewed from the output end. Each power output is isolated, so outputs of positive or negative polarity can be configured through proper selection of the output reference terminal.

In order to minimize parasitic cable inductance and reduce EMI, the output power cables should be routed in close proximity to one another, and large current loops should be avoided. To avoid excessive voltage drop, do not undersize power cables, especially for high current outputs. Do not bulk input AC wires with the output wires which can increase EMI. Excessive cable inductance coupled with large capacitive loading can introduce instability in switching power supplies. This problem can be avoided with proper system design. Consult Vicor's Applications Engineering Department for assistance with applications that use long cable lengths and excessive load capacitance.

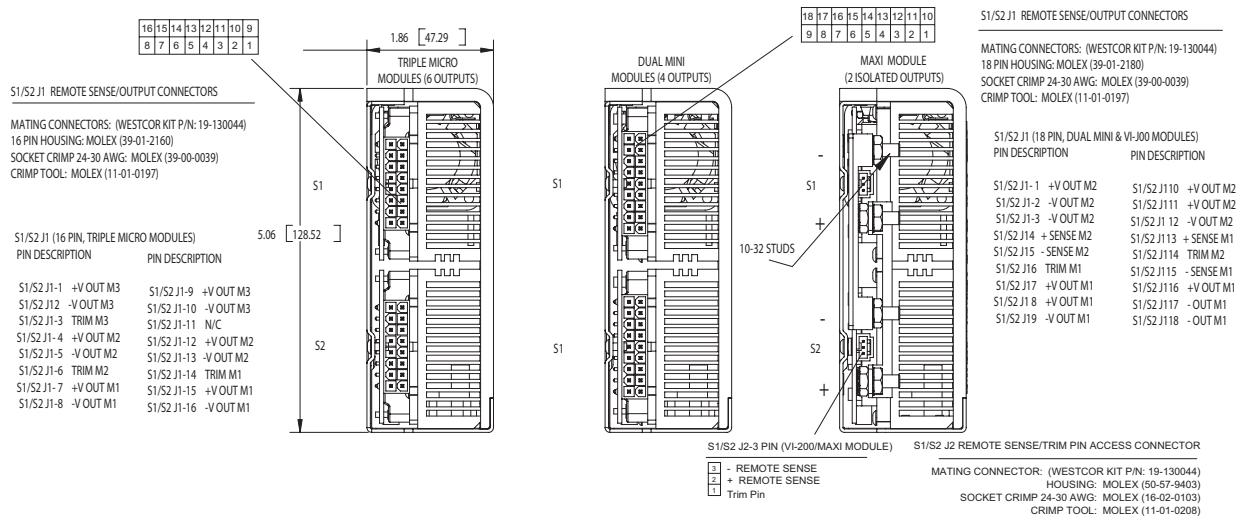

Figure 3. Output Power Connections

User Interface Connections

Signal Ground (CBJ3-1)

Signal Ground on CBJ3-1 is an isolated secondary ground reference for all CBJ3 interfacing signals. This is **not** the same as Earth Ground on input power connector MBJ1.

Bi-directional I/O lines (CBJ3-4 to CBJ3-9) (Enable/Disable or Module Power Good Status)

Enable/Disable Mode

Enable/Disable mode is the default condition for these I/O lines. In this mode, the control pins allow the outputs to be sequenced either ON or OFF. To disable a module, the E/D pin should be pulled low to less than 0.7V with respect to Signal Ground. The E/D lines will typically source 250 μ A (1mA max.) under this condition. To enable a module, a E/D pin should be open circuited or driven high to a logic high voltage of 3.5V (40 μ A typical) or greater not to exceed 5V. (When one has a two module array, use GSD to disable the output instead of using E/D.)

The correspondence between a module and its E/D line as seen from the output end of the power supply goes from left to right. The PFC Micro Power Supply is a two slot box. Slot 1 is the left slot and Slot 2 is the right slot. See Table 1. E/D1, E/D2, E/D3 correspond with V_{out} M1, V_{out} M2 and V_{out} M3 on slot 1. E/D4, E/D5, E/D6 correspond with V_{out} M1, V_{out} M2 and V_{out} M3 on slot 2.

| | Slot 1 | | | Slot 2 | | |
|----------------|--------|------|------|--------|------|------|
| | E/D1 | E/D2 | E/D3 | E/D4 | E/D5 | E/D6 |
| Maxi Modules | X | | | X | | |
| Mini Modules | X | X | | X | X | |
| Micro Modules | X | X | X | X | X | X |
| VI-200 Modules | X | | | X | | |
| VI-J00 Modules | X | X | | X | X | |

Table 1: Enable/Disable Mode

Module Power Good Status Mode

The power supply will enter the Power Good Status Mode when logic high (50 μ A typical) is applied to Power Good Read (PGR) pin (CBJ3-2). While in the PGR mode the I/O lines (CBJ3-4 to CBJ3-9) will be outputs. They will have a source capability of 5mA. These outputs give an indication of the status of the modules of the power supply. A TTL "1" (>3.5V) on a line indicates the module is ON and functioning properly. And a TTL "0" (<0.7V) indicates the module is either OFF or is not functioning properly. The correspondence between the module and the Power Good Status of that module is the same as between a E/D pin and its module.

Procedurally, certain guidelines must be followed when using this feature. Upon application of a logic high on the Power Good Read (PGR) pin, the user must change its E/D interface (CBJ3-4 to CBJ3-9) from outputs to inputs within 3 ms. The Power Good Status data will be valid on the E/D lines when the Power Good Data Valid (PGDV) pin (CBJ3-11) asserts to a logic high. The power good status measurement takes typically 200ms. While in the Power Good Read Mode (PRG=1) the individual shutdown lines are not functional. However, General Shut Down (GSD) is functional. Leaving the Power Good Read mode is accomplished by removing the logic high or applying a logic low (<0.7V) to the Power Good Read (PGR) pin (CBJ3-2). The user must change its E/D interface (CBJ3-4 to CBJ3-9) from inputs to outputs between 1ms and 4ms of the time the PGR low is applied to pin CBJ3-2.

Note: If any model is disabled by the user when a Power Good Read is requested (PGR=1), that module will remain off during the Power Good Read and status of said module will be power not good (<0.7V). Power Good Read status data on open E/D lines are not valid. An open E/D line is a E/D pin where there is no module associated with said E/D line (i.e. A power supply with two Maxi modules, Data on E/D2, E/D3 and E/D5 and E/D6 are NOT valid.

The Power Good Status Mode feature is only valid for when (Maxi, Mini and/or Micro modules are used).

General Shutdown /GSD (CBJ3-10)

The GSD control pin on CBJ3-10 allows simultaneous shutdown of all outputs. This pin must be pulled down to less than 0.7V, and will typically source 250 μ A (1mA maximum) to shut down all outputs. The GSD pin should be open circuited or driven high to a logic high voltage of 3.5V or greater when not in use, or when the outputs are to be enabled. Do not apply more than 5V to this input.

AC OK (CBJ3-3)

AC OK is an active high TTL compatible signal and provides a status indication of the AC input power. It is on pin CBJ3-3 and is capable of sinking 5 mA maximum. This signal switches to a TTL "1" when the high voltage bus exceeds low-line condition during turn-on. Upon loss of input power, the bus voltage will drop, causing the AC OK signal to go low. Typically, a 3 ms holdup time is provided for a 500W load following the loss of the AC OK signal.

Auxiliary Vcc +5V/40mA (CBJ3-12)

The Vcc on CBJ3-12 is an auxiliary 5V regulated power source. It is +5 Vdc \pm 5% with respect to Signal Ground and can supply 40 mA maximum. It is capable of withstanding a short, but shorted user interface functionality will be lost.

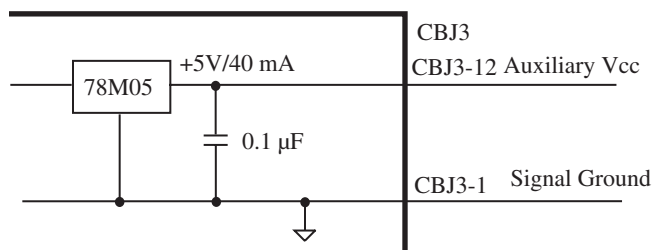

Figure 4. Auxiliary Vcc

Power Good Read (PGR, CBJ3-2)

This pin initiates the Power Good Read sequence. A logic high applied to this pin will cause the power supply to enter the Power Good Read status mode. In this mode, the I/O lines (CBJ3-4 to CBJ3-9) will be outputs. These outputs give an indication of the status of the modules of the power supply. A high on an I/O line (CBJ3-4 to CBJ3-9) indicates a module is ON and functioning and a low indicate the module is OFF or in a fault condition. The Power Good Status data will be valid on the ED lines (CBJ3-4 to CBJ3-9) when the Power Good Data Valid (PGDV) pin (CBJ3-11) asserts a logic high. Applying a logic low or opening the PGR pin puts the power supply back in the Enable/Disable mode. I/O line (CBJ3-4 to CBJ3-9) will be inputs and control the enabling and disabling of the output modules. The PGR pin will source 250 μ A typically (1mA max.)

Power Good Data Valid (PGDV- CBJ3-11)

Upon entering the Power Good Read status mode (PGR=1, CBJ3-2), the data will not be valid on the I/O lines (CBJ3-4 to CBJ3-9) until the PGDV pin asserts itself logic high. This pin can source up to 5mA. When this pin is logic low, Power Good status data is not valid or the power supply is not in the Power Good Read status mode.

+Sense/-Sense (S1/S2 J2)

The sense lines for the outputs are shipped from the factory with Autosense. Autosense provides the user with automatic sensing of the outputs. With Autosense, the PFC Micro will automatically operate in a Remote Sense mode when the Remote Sense connections are made. But in the event that the Remote Sense is not connected or needed, no Local Sense selection is necessary - simply hook up the outputs and the PFC Micro will automatically operate in Local Sense mode.

In the local sense mode (Remote Sense lines not connected), the power supply will regulate the output at the output terminals. The voltage appearing at the load may drop slightly due to voltage drop in the power cables. If it is necessary to compensate for voltage drop along the output power cables, the output can be trimmed up or configured for Remote Sense. Use stranded twisted pair 20-22 AWG wire for the Remote Sense lines. Remote Sense can compensate for a voltage drop of up to 0.5V, or 0.25V on each leg.

The Sense connector for a single output board is a 3 pin connector providing the +Sense connection on S1/S2 J2-2 and the -Sense connection on S1/S2 J2-3. The Sense connector for a dual output board is provided on the 18 pin output connector that also provides the output and trim connections. +Sense and -Sense for the first output are located on S1/S2 J1-13 and S1/S2 J1-15, respectively. +Sense and -Sense for the second output are located on S1/S2 J1-4 and S1/S2 J1-5, respectively. Remote sense is not available for Triple output configurations.

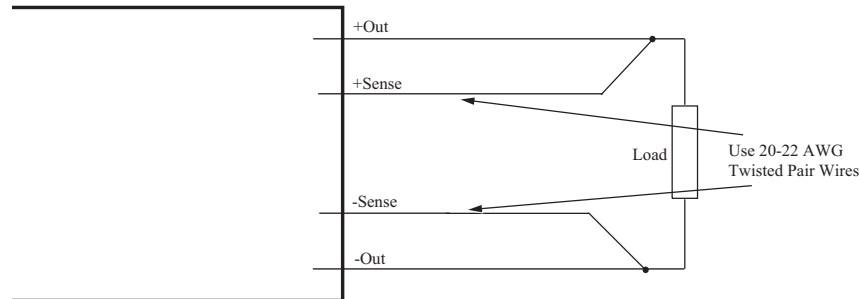

Figure 5. Remote Sense

External Trim (S1/S2 J2)

The Trim pin at S1/S2 J2 is referenced to the -Sense pin and can be used for external control of the output voltage. For triple output cards, the Trim pins are available on S1/S2 J2-14, S1/S2 J2-6 and S1/S2 J2-3 for outputs 1, 2 and 3 respectively. For dual output cards, the Trim pins are available at S1/S2 J2-6 and S1/S2 J2-14 for outputs 1 and 2, respectively. For a single output card, the Trim pin is S1/S2 J2-1. A 10% increase to the trim pin voltage will result in a 10% increase in output voltage. Reducing the trim pin voltage by 10% will result in a 10% decrease in output voltage.

| OUTPUT MODULE | V_{ref} | R_{TH} |
|---------------------------|-----------|-----------------|
| VI-200/VI-J00 $\geq 3.3V$ | 2.5V | 10k Ω |
| VI-200/VI-J00 $< 3.3V$ | 0.97V | 3.88k Ω |
| Maxi (Predefined) | 1.23V | 1k Ω |
| Maxi (Userdefined) | 1.23V | Consult Factory |

Table 2. Module Internal Reference Voltages and Thevenin Resistances.

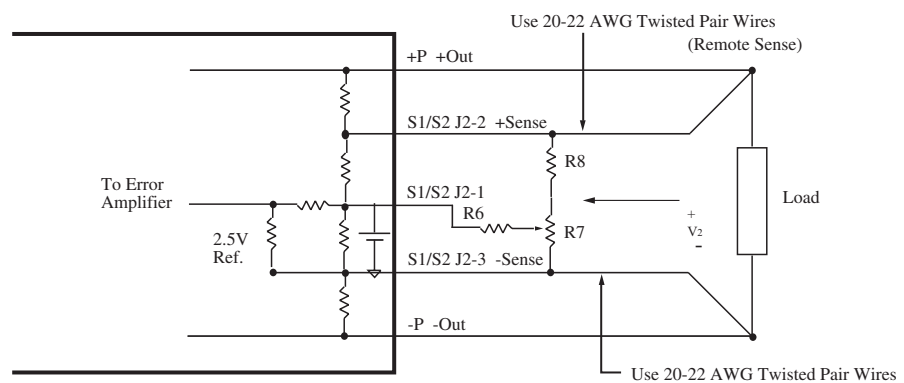

Figure 6. External Trim

Example:**±10% trim adjust on a 12V nominal output.**

Figure 6 shows a typical variable trim circuit. Using a 10k trimpot (R7), the resistor values for R6 and R8 can be calculated as follows:

$$V_1 = V_{\text{ref}} + 10\% = 2.75\text{V}$$

$$\text{Given: } V_{\text{ref}} = 2.5\text{V (see Table 2)}$$

$$I_{R5} = (2.75\text{V} - V_{\text{ref}})/R_{\text{TH}} = (2.75\text{V} - 2.5\text{V})/10\text{k}\Omega = 25\mu\text{A}$$

$$\text{Given: } R_{\text{TH}} = 10\text{k}\Omega \text{ (see Table 2)}$$

Setting the bottom limit:

$$V_{R6} = 2.5\text{V} - 10\% = 2.25\text{V}$$

And since $I_{R5} = I_{R6} = 25\mu\text{A}$,

$$R6 = V_{R6}/I_{R6} = 2.25\text{V}/25\mu\text{A} = \underline{90\text{k}\Omega}$$

$$V_2 = V_1 + V_{R6} = 2.75\text{V} + 2.25\text{V} = 5\text{V}$$

$$I_{R7} = V_2/R7 = 5\text{V}/10\text{k}\Omega = 500\mu\text{A}$$

$$I_{R8} = I_{R7} + I_{R6} = 525\mu\text{A}$$

$$V_{R8} = (V_{\text{nom}} + 10\%) - V_2 = 13.2\text{V} - 5\text{V} = 8.2\text{V}$$

$$\text{Given: } V_{\text{nom}} = 12\text{V}$$

$$R8 = V_{R8}/I_{R8} = 8.2\text{V}/525\mu\text{A} = \underline{15.62\text{k}\Omega}$$

Consult Applications Engineering when trimming outputs below 5V.

Single Output Power Supplies (Arrays)

Westcor's standard configuration for single output power supplies is to set the left module (as seen from looking at the power supply output) as the controlling module of the array.

Specifications (Typical at 25°C, nominal line and 75% load, unless otherwise specified)**GENERAL**

| | |
|----------------------------------|---|
| Number of Outputs Modules | 1-6 VI-200/VI-J00: Two VI-200s or Four VI-J00s Maxi: Two Maxis, Four Minis or Six Micros |
| Efficiency | Typically > 75% |
| Safety Agency Approvals | TUV CUE Standards: CSA-C22.2 No. 60950-00, UL 60950 3rd Edition, EN 60950:2000 CE Mark to the LVD, 73/23/EEC amended by 93/68/EEC |
| Maximum Output Power | 500W at 115Vac, (100 Vac minimum input) ⁺ 800W at 230Vac, (200 Vac minimum input) |

⁺ Note; Not to exceed an input current of 7.5A.

INPUT

| | |
|--|--|
| Input | 85-264 Vac, 47-500Hz 100-300 Vdc (derated output level) |
| VI-200/VI-J00 Line/Load Regulation | 0.2% max. from 10% to full load 0.5% max. from no load to 10% load |
| Maxi/Mini/Micro Line Regulation* | 0.20% max to 0.30% max |
| Maxi/Mini/Micro Load Regulation* | 0.20% max to 0.70% max |
| Inrush Current | 5A rms @ 115 Vac 1A rms @ 230 Vac |
| Ride Through Time | >20 ms at 500W load (nominal load) |
| Conducted EMI | FCC Class A EN 55022 Class A (consult factory) |
| Power Factor | >.98 |
| Transient Burst Immunity | EN61000-4-4 (consult factory) |
| Surge Immunity (Common Mode & Normal Mode) | Compliant with IEC 61000-4-5, Level 3, Performance Criteria B (Temporary loss of output power may occur which is self recoverable.) |
| Dielectric Withstand | Primary to Chassis GND = 2,121 Vdc Primary to Secondary = 4,242 Vdc Secondary to Chassis GND = 750 Vdc |

* See Vicor module specifications. A preload may be necessary for modules trimmed down below 90% of normal output voltage.

OUTPUT**VI-200/VI-J00 Modules**

| Parameter | MIN. | TYP. | MAX. | UNITS | NOTES |
|--|------------------------|-------------|-------------|--------------|----------------------------|
| Setpoint Accuracy* | | 0.5 | 1 | % | of Vnom |
| Load/line Regulation | | 0.05 | 0.5 | % | LL to HL, 10% to Full Load |
| Load/line Regulation | | 0.2 | 0.5 | % | LL to HL, No Load to 10% |
| Temperature Regulation | | 0.01 | 0.02 | %/°C | Over rated temp. |
| Long Term Drift | | 0.02 | | %/K hours | |
| Output Ripple & Noise: | | | | | |
| ≤ 10V out | | 100 | | mV | 20 MHz bandwidth |
| > 10 V out | | 1.0 | | % Vout | 20 MHz bandwidth |
| Voltage Trim Range | | | | | |
| VI-200/VI-J00 Slots | | 50-110 | | % V out | ± 10% on 10-15 Vout |
| Total Remote Sense Compensation | 0.5 | | | Volts | Autosense. See pg.6 & 11 |
| OVP Set Point¹ | 115 | 125 | 135 | % Vout | Recycle Power |
| Current Limit | 105 | 115 | 125 | % of I max | Auto Recovery |
| Short Circuit Current | 20 (105 ²) | | 130 | % | |
| Overtemperature Limiting | | | | | Not available on VI-J00 |

* For special and adjustable voltages, maximum setpoint accuracy is 2% of Vnom.

¹ 131% Nominal for Booster Modules. No OVP for VI-J00

2 VI-J00 modules only.

OUTPUT (CONT'D.)**Maxi, Mini and Micro series modules**

| Parameter | MIN. | TYP. | MAX. | UNITS | NOTES |
|--|-------------|-------------|-------------|-----------------------|--------------------------|
| Setpoint Accuracy* | | ±0.5 | ±1 | % of V _{NOM} | |
| Load/line Regulation | | ±0.08 | ±0.45 (±7) | % of V _{NOM} | 0% to 100% |
| Temperature Regulation | | 0.002 | 0.005 | %/°C | -20 to 100°C |
| Long Term Drift | | 0.02 | | %/K hours | |
| Output Ripple and noise: | | | | | |
| ≤ 10V out | | 100 | | mV | 20 MHz bandwidth |
| > 10 V out | | 1.0 | | % V _{out} | 20 MHz bandwidth |
| Voltage Trim Range | | | | | |
| Maxi/Mini/Micro Slots | | 10-110 | | % V _{out} | Preload may be required. |
| Total Remote Sense Compensation | 0.5 | | | Volts | Autosense. See pg.6 & 11 |
| OVP Set Point | 112 | | 135 | % of V _{out} | Recycle power |
| Current Limit | 102 | 115 | 135 | % of I max | Auto Recovery |
| Overtemperature Limiting | | | | | Not available |

* For special, adjustable voltages and 48Vdc outputs, maximum setpoint accuracy is 2% of V_{nom}.

Note: See individual module datasheets for specific module specifications.

ENVIRONMENTAL

| | |
|------------------------------|----------------|
| Storage Temperature | -40°C to +85°C |
| Operating Temperature | |
| Full Power | -20°C to +45°C |
| Half Power | -20°C to +65°C |

Specific temperature data on all module configurations can be obtained by contacting Applications Engineering.

| | |
|-----------------------|---|
| Altitude | Derate 2.6% total output power for each 1,000 ft to a maximum operating altitude of 15,000 ft. Non-operating storage maximum altitude is 40K. |
| Humidity | 0 to 95% non condensing |
| Product Weight | 5.2 lbs. (2,4 kg) |
| Dimensions | 1.86" H (47,3mm) x 5.06" W (128,5mm) x 10.40" L (264,1mm) |
| Warranty | 2 years limited warranty. See vicorpower.com for complete warranty statement. |

Output Power Derating

PFC Micro Output Power vs. AC Input Voltage

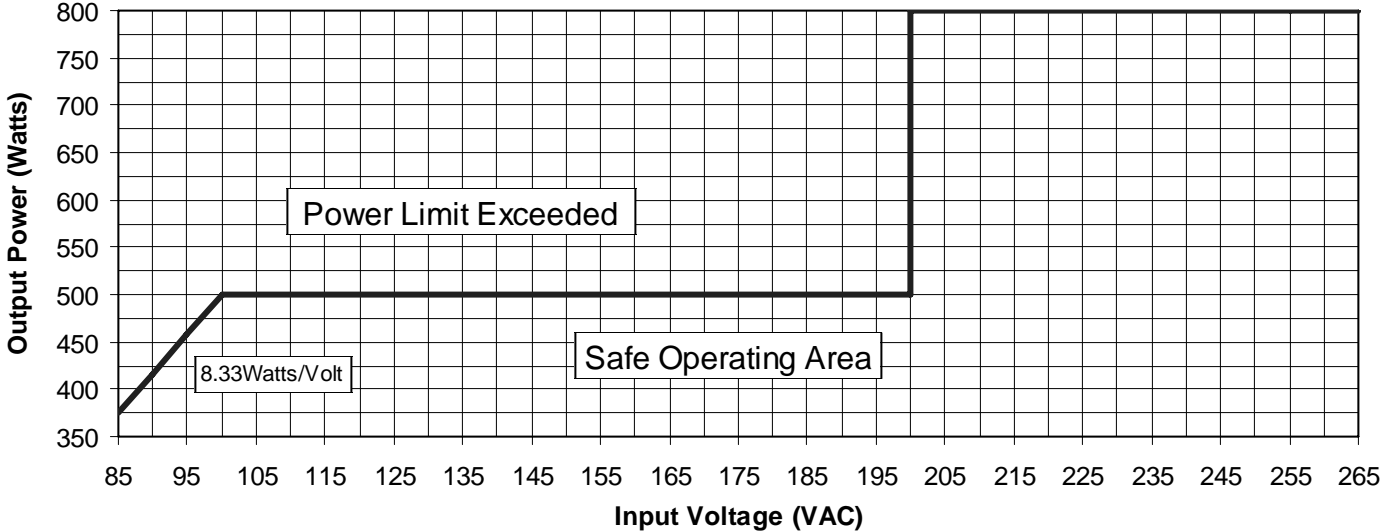

PFC Micro Output Power vs. DC Input Voltage

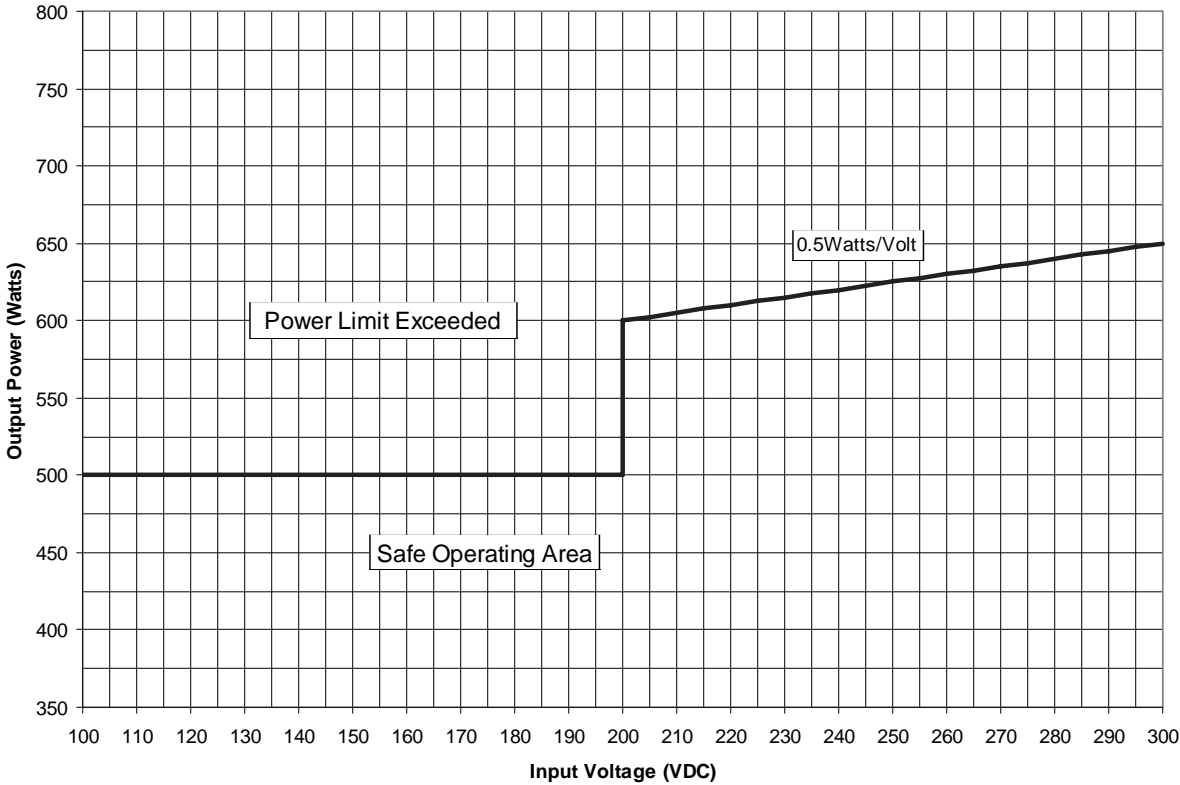

Output Power Derating -Continued

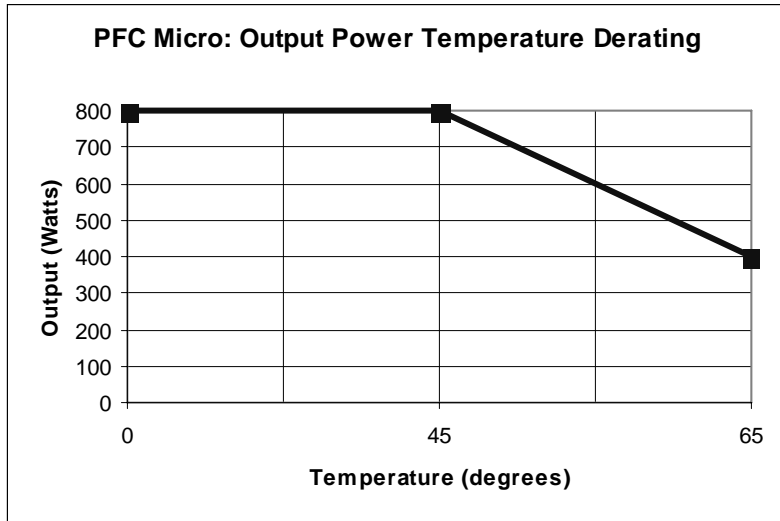

1. For all module configurations. The PFC Micro or an individual output may be limited by module power limitations e.g. 5V Maxi module is 400W maximum. One cannot exceed the output power rating of the PFC Micro regardless of the module capability.
2. Also see Output Power vs Input Voltage charts on page 17.

CURRENT SHARE BOARD - Optional Feature

"Current sharing" also known as Load Sharing, is the ability to divide the output current evenly across all active power supplies. This greatly reduces stresses on each power supply and allows them to run cooler, resulting in higher reliability. Standard "current sharing" techniques typically utilize shunt resistors or Hall Effect devices to measure the current from each power supply. Power shunt resistors continually dissipate power and require cooling especially when dealing with high output currents of >100Amps. Hall Effect devices measure magnetic fields generated by current flowing through a conductor and, although they dissipate no power, they tend to be large and expensive.

First developed by Westcor Engineering for paralleling MegaPAC supplies, the Box-to-Box Current Share Board or CSB allows two or more Vicor power supplies to current share by utilizing the inherent voltage drop produced in the negative output return cable. This eliminates the need for additional shunt resistors or expensive Hall Effect devices and provides a simple 5 wire connection method to achieve a +/-1mV accuracy between the Negative Output power rails. This accuracy translates to a 1% current sharing if there is a total of 100mV conduction voltage drop in the negative return path.

Constructed as a current source to drive the Trim pin of a Vicor module, the design uses an accurate comparator circuit to monitor the power returns. In addition, the circuit is unidirectional and can only trim an output voltage up. The benefit is that only the supply that is supporting less current is adjusted up. This action balances the currents to the load by matching the output voltages of the supplies. In the case of one supply failing, the circuit will attempt to trim the failed supply only. This will leave the remaining functional supply alone to provide power to the load at its nominal voltage. Thus the circuit also offers simple redundancy. In addition,

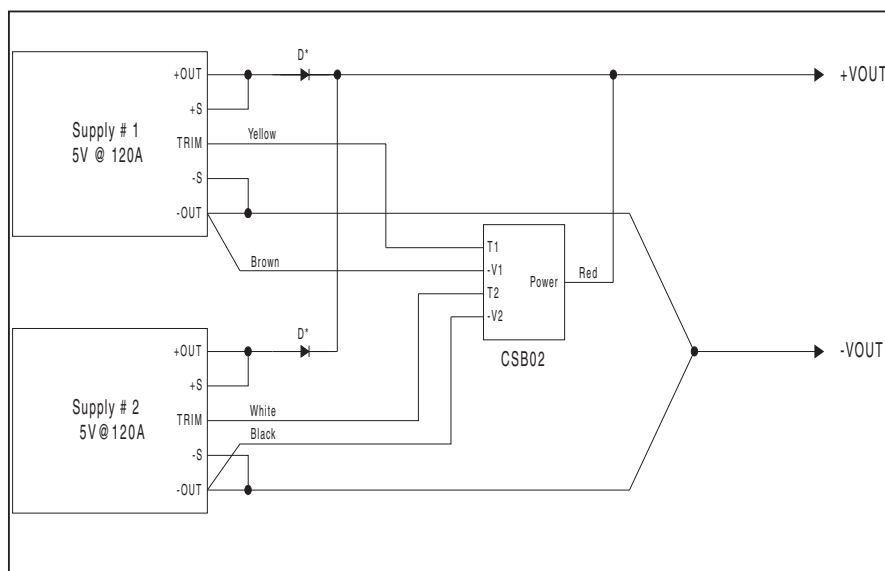

Figure 1. CSB Interconnect Example

because CSB functions as a current source, the Trim outputs (T1 and T2) of the CSB can be placed in parallel to create a summing node. This allows current sharing between more than two supplies by paralleling the T2 output of one CSB circuit with the T1 output of the next CSB.

Please note: The CSB is not intended for use in Hotswap Applications.

Requirements:

1. For proper operation, the power supplies being paralleled should be enabled at the same time.
2. -Out conductors must be of equal length and wire gauge. Separate -Out conductors must be used from each supply to the load, or the use of a "Y" connection to a common point must be used as shown in figure 1. Each leg of the "Y" must have a minimum of a few millivolts of drop in order for proper operation. 50mV to 100mV of drop will provide from 5% to 1% accuracy.
3. -V1 and -V2 for all Box-to-Box circuits must be connected directly at the negative output power studs or terminals to achieve accurate current sharing.
4. D* can be added if redundancy is needed. If redundancy is not required, D* can be replaced with direct wire connections.
5. When using D*, the Power input should be connected on the cathode side of the paralleling diodes as shown above.
6. Terminate Sense Leads either locally or remotely as shown in figure 1.
7. For paralleling more than 2 supplies consult factory for assistance.

CURRENT SHARE BOARD -Continued

J1 Pinout

| Pin | Description |
|-----|---------------|
| 1 | Power |
| 2 | T1 |
| 3 | -V1 |
| 4 | T2 |
| 5 | -V2 |
| 6 | No Connection |

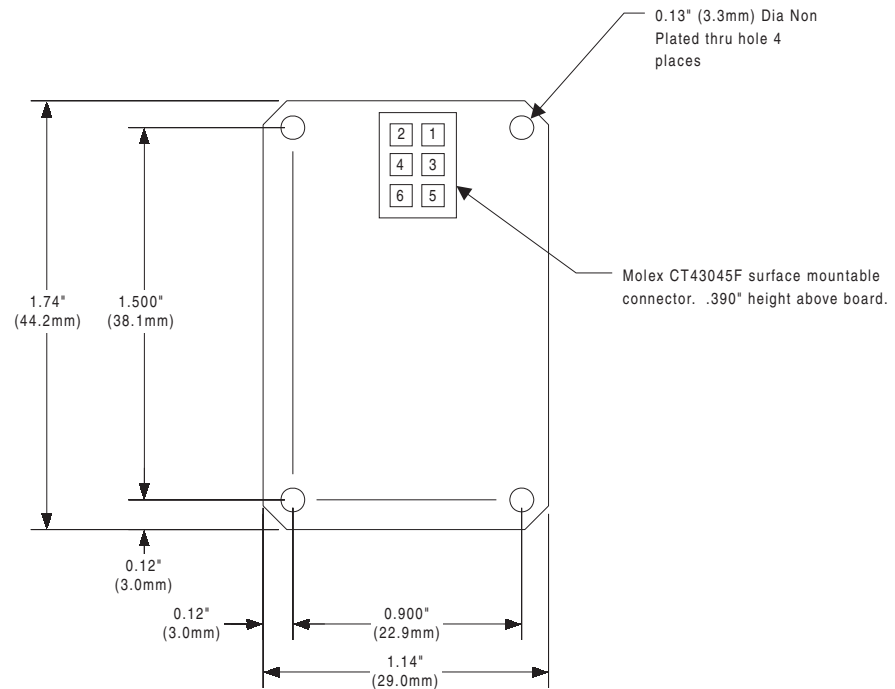

Figure 2. Mechanical Drawing

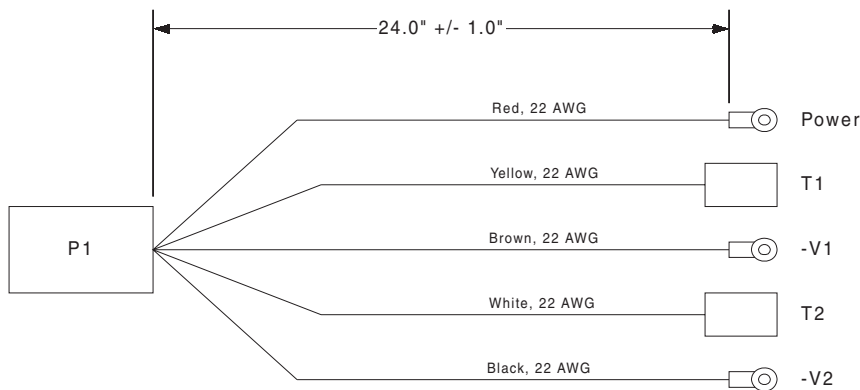

Figure 3. Cable Drawing

Specifications:

1. Power: 2-50Vdc at 5mA maximum.
2. Accuracy: +/- 1mV between -Vout connections.
3. Output current when not trimming up: +/- 1uA (VI-200/J00), +/-5uA (Maxi).
4. Use 4 non-plated through holes with standoffs for mounting.
5. CSB01 MUST be used for current sharing VI-200/VI-J00 converters .
6. CSB02 MUST be used for current sharing Maxi/Mini/Micro converters .

*****PLEASE NOTE, THE CSB IS NOT INTENDED FOR HOTSWAP APPLICATIONS*****

Contact your Regional Applications Engineer at 1-800-927-9474 for additional information.

Notes

VICOR GLOBAL OFFICES

USA

**Vicor Corporation,
Corporate Headquarters**
25 Frontage Road
Andover, MA 01810
Tel: 800-735-6200,
Tel: 978-470-2900
Fax: 978-475-6715

Vicor Corporation
377 E. Butterfield Road
Suite 201
Lombard, IL 60148
Tel: 630-769-8780
Fax: 630-769-8782

Vicor, Westcor Division
560 Oakmead Parkway
Sunnyvale, CA 94085
Tel: 408-522-5280
Fax: 408-774-5555

EUROPE

Vicor France
Tel: 33-1-3452-1830
Free Phone
France Only:
0800 419 419
Fax: 33-1-3452-2830
Email: vicorfr@vicr.com

Vicor Italy
Tel: +39-02-2247-2326
Free Phone *Italy Only:*
800-899-677
Fax: +39-02-2247-3166
Email: vicorit@vicr.com

Vicor Germany
Tel: +49-89-962439-0
Free Phone
Germany Only:
0800 018 29 18
Fax: +49-89-962439-39
Email: vicorde@vicr.com

Vicor U.K.
Tel: +44-1276-678-222
Free Phone *UK Only:*
0800-980-8427
Fax: +44-1276-681-269
Email: vicoruk@vicr.com

ASIA-PACIFIC

Vicor Hong Kong
Tel: +852-2956-1782
Fax: +852-2956-0782

Vicor Japan Co., Ltd.
Tel: 81-3-5487-3880
Fax: 81-3-5487-3885

For more information about this or other Vicor products, or for assistance with component-based power system design, contact the Vicor office nearest you. Vicor's comprehensive line of power solutions includes modular, high-density DC-DC converters and accessory components, configurable power supplies, and custom power systems. Westcor, a division of Vicor, designs and builds fan cooled, configurable power supplies incorporating Vicor's high density DC-DC converters and accessory components. Westcor's product line includes:

LOPAC FAMILY:

- PFC MicroS
- PFC Micro
- PFC Mini

MEGAPAC FAMILY:

- PFC MegaPAC
- Mini MegaPAC
- 4kW MegaPAC-EL (Low Noise)
- PFC MegaPAC-EL (Low Noise)
- Autoranging MegaPAC
- PFC MegaPAC-HPEL
- PFC MegaPAC (High Power)
- 4kW MegaPAC
- ConverterPACs

OTHERS:

FlatPAC-EN

Information furnished by Vicor is believed to be accurate and reliable. However, no responsibility is assumed by Vicor for its use. No license is granted by implication or otherwise under any patent or patent rights of Vicor. Vicor components are not designed to be used in applications, such as life support systems, wherein a failure or malfunction could result in injury or death. All sales are subject to Vicor's Terms and Conditions of Sale, which are available upon request.

Specifications are subject to change without notice. *The latest data is available on the Vicor website at vicorpower.com*



www.westcorppower.com